



'S' Type Diaphragm Valves



Valves are available in manual and actuated styles and we are able to modify our castings to fit any suitable type of electric, pneumatic or hydraulic actuator.

Remember, Warren-Morrison manufactures tailor made valves and is able to offer flexible options to suit customers' exact specifications.

Diaphragms

The Warren-Morrison 'S' Type Diaphragm Valve is of an advanced design that provides a straight through flow with a diaphragm moulded in the open position.

This is achieved by employing a curved bonnet flange and a diaphragm so moulded that it moves from the open to closed position merely by partially straightening its curved surfaces and, therefore, no undue stress is applied.

Moulded into the rubber is a synthetic fibre reinforcement and diaphragm stud by which the diaphragm is attached to the compressor.

To ensure correct sealing it is essential that the bonnet assembly is in the closed position when a diaphragm is fitted to a valve body.

Warren-Morrison Diaphragm Valves are of an advanced design which provides straight through flow whilst restricting to a minimum of the flexing stress imposed on the diaphragm.

The internal contours of the body ensure smooth flow and are suitable for all types of protective lining. A wide selection of body materials coupled with a variety of highly developed rubbers and synthetics for the diaphragm enable the valve to handle the widest possible range of duties.

The diaphragm is moulded

in the open position and has, therefore, no tendency to stick closed. The body design gives very low flow resistance and the valve can be rodded should build up occur in adjacent pipework.

A further refinement of the 'S' Type Valve is the design of common bonnet assemblies resulting in fewer spare diaphragms needed to cover the full range of valve sizes.

Standard production of the 'S' Type covers sizes DN15 to DN450 and the range includes options for handwheel, pneumatic,

electric and hydraulic operation. Glass lined valves to BS 5156 are up to 1 mm longer than unlined but the glass lining does not affect the overall length of valves to DIN 3202F1.

Standard production covers sizes up to DN80 with screwed ends (BSP, API, NPT etc.), socket and butt weld. DN15 to DN450 with flanged ends (BST D/E, ASA 125/150 or metric). Face to face dimensions for flanged valves are to BS 5156 or DIN 3202F1.

All 'S' Type Diaphragm

'S' Type Diaphragm Valve Typical Applications

- Water treatment - demineralisation, potable water treatment, acids, alkalis, effluent, treated sludges, effluent treatment
- Corrosive mineral acids - sulphuric, hydrochloric, nitric, hydrofluoric
- Chlor-alkali - chlorine, caustic soda, sodium hypochlorite, brine, pure water, gases
- Petroleum based organics - diesel, paraffin, organic acids
- Toxic hazardous chemicals and gases
- Power plant generation - hydrogen, acids and alkalis
- Pulp and paper production - bleach, pulp slurry, black and green liquors, chlorine gas
- Fire and safety - fire mains valves, wet riser landing valves on high rise buildings
- Pressure relief valves on sludge lines
- Compressed air lines - 100% shut off

Please contact Warren-Morrison Valves for more details

Standard Body Materials:

- Grey Iron BS1452
- S. G. Iron to BS2789
- Stainless Steel
- Carbon Steel
- Aluminium BS1490
- Bronzes to BS1400

Standard Body Linings:

- Hard rubber
- Soft rubber
- EPDM
- Butyl
- Neoprene
- Hypalon
- Blue glass
- PVDF
- Polypropylene
- Halar (ECTFE)
- HPE
- RT 9000

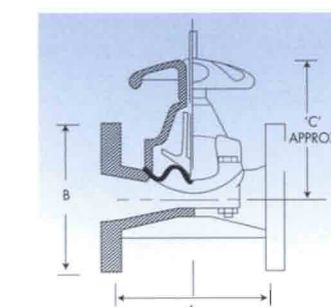

'S' Type Diaphragm Valve

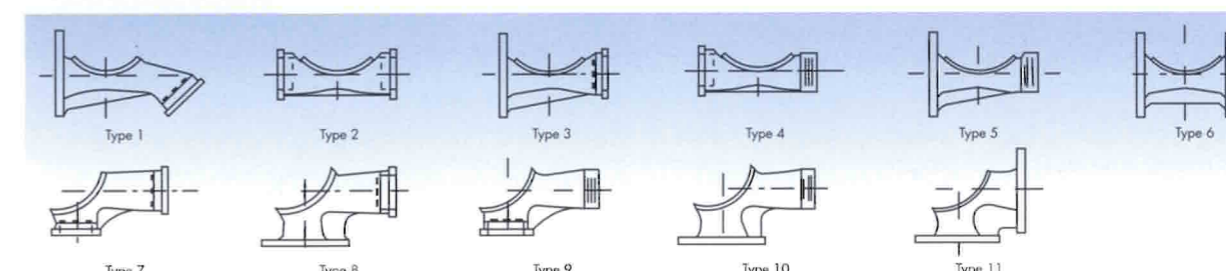

End connections available for 'S' and 'SFV' valves

Dimensions in millimetres (BASED ON BS 4504 PN 16)

Nominal Bore		15	20	25	32	40	50	65	80	100	125	150	200	250	300	350	400	450
Unlined to BS 5156	A	108	117	127	146	159	190	216	254	305	356	406	521	635	749	749	1100	1200
Rubber lined to BS 5156	A1	114	123	133	152	165	196	222	260	311	362	412	527	641	755	755	1112	1212
Unlined and rubber lined to DIN 3202 F1	A2	130	150	160	180	200	230	290	310	350	400	480	600	730	850	980	1100	1200
Flange Diameter	B	65	105	115	140	150	165	185	200	229	254	285	343	406	483	534	580	641
Height from centre	C	62	62	89	89	152	152	172	172	229	286	286	406	406	600	600	660	654
Weight cast iron to BS 5156	kg	2	2.3	3.6	3.8	6	9	13.2	15	28.1	45.4	60	125	152	375	409	660	680
Weight cast iron to DIN 3202 F1	kg	2.7	3	4.5	5	9.5	11	17.7	19	31	51.3	65	143	174	424	*	*	*
Standard Pressure rating (Higher pressure ratings are available)	bar	16	16	16	16	16	16	10	10	10	10	10	10	10	10	10	10	10

Flanged ends drilled to BST D/E, ANSI 125/150 or metric or to your requirements * Details on application



True full bore Pinch Valves



MK 4 PINCH VALVE

The Warren-Morrison Pinch Valve is the number one choice for controlling the flow of corrosive or abrasive slurries, powders and granular material and is equally efficient when handling gases and viscous liquids.

For added safety Warren-Morrison Pinch Valves are normally supplied with totally enclosed bodies acting as a secondary containment system. Open bodied versions are also available for less critical applications.

The easily replaceable rubber sleeve is the only part in contact with the medium, thus eliminating gland leaks and the problems associated with jamming mechanisms.

Correct selection of sleeve elastomer will ensure maximised maintenance schedules and the ease of sleeve replacement minimises downtime.

All sizes are suitable for use in food and brewing industries and we offer a food quality EPDM rubber

sleeve suitable for occasional steam sterilisation at 140°C.

The Mark 4 Pinch Valves have both pressure ratings and face to face dimensions to BS5156 which allows interchangeability with lined diaphragm valves.

All Pinch Valves are available in manual and actuated styles and we are able to modify our castings to fit any suitable type of electric, pneumatic or hydraulic actuator.

Depending on the size and application, Warren-Morrison Pinch Valves use either one or two moving pinch bars to effect closure.

The single pinch bar type closes against the lower valve body whereas the two pinch bar type closes on the centerline.

The sleeve prevents the body being exposed to the media, therefore in normal cases we would recommend the use of aluminium bodies as being light in weight and less costly. However, in certain applications the customer may require an alternative material in which case we offer a range suitable for most situations.

Warren-Morrison Pinch Valves are designed to give long, trouble-free service; this will only be achieved if the most suitable material is used. Standard materials as listed below will cover most requirements.

Warren-Morrison will always be prepared to advise on the most suitable elastomer.

Warren-Morrison Pinch Valve sleeves are moulded either as true full bore or with a reduced bore for specific control applications.

Reduced bore sleeves are sized according to the customers' requirements.

For vacuum duty the sleeves are moulded with 'assist to open lugs' which locate in slotted pinch bars to ensure efficient operation.

Dimensions & Materials

Pinch Valve - Typical Applications

- Ceramics - slip and glaze, clays
- Waste treatment incinerators - line dosing control valves
- Mining - tailings and slurries, flotation, hydrocyclones
- Water treatment - granular activated carbon, micro-sand separation
- Nuclear fuels - cement grout control lines
- Cement manufacture - hopper vent valves
- Food process - isolation and control valves
- Paper and pulp - Reausticising, washing, screening, pulp lines, re-cycled paper handling
- Ink and paint manufacture - control of raw and finished products
- Iron and steel manufacture - control of additives, e.g. Manganese
- Chemical industry - abrasive, viscous and noxious media
- Oil and gas exploration and production - drilling mud and screenings

Body Materials:

- Aluminium BS1490
- Grey Iron BS1452
- Bronzes to BS1400
- S. G. Iron to BS2789
- Stainless Steel
- Carbon Steel
- Engineering Plastics

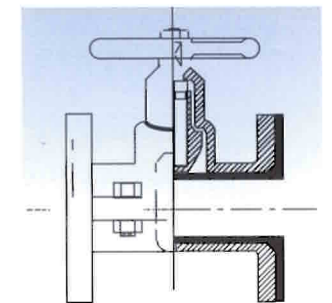

Fully enclosed single pinch bar pinch valve

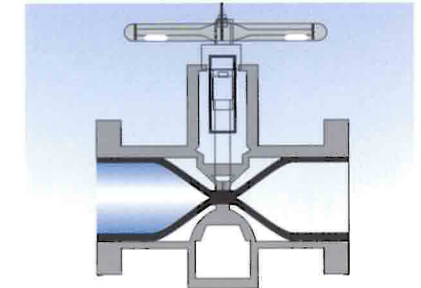
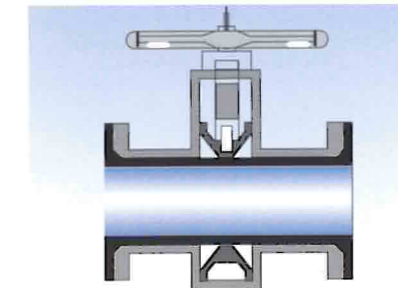
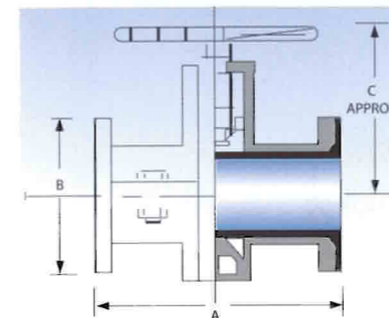

Fully enclosed double pinch bar pinch valve, half cross section, open valve, closed valve.

Dimensions in millimetres (BASED ON BS 4504 PN 16)

Nominal Bore		15	20	25	40	50	65	80	100	125	150	200	250	300	350
Length to BS 5156	A	114	123	133	165	196	222	260	311	362	412	527	881	749	1229
Flange Diameter	B	95	105	115	150	165	185	200	229	254	285	343	406	457	527
Height from centre - manual operation	C	102	108	127	152	184	222	222	267	324	381	470	572	622	686
Centre line to cylinder end - actuator operation	D	These dimensions are determined by the maximum working pressure and minimum air available to operate the cylinders													
Weight-Aluminium - manual operation	kg	1.4	2	2.7	4.6	7.3	9.6	11.8	20.3	32.5	44.2	95	185	358	*
Weight-Cast Iron - manual operation	kg	3.4	3.9	5.6	9.4	14.5	19.1	23.2	41	74	92	196	454	606	750
Pressure Rating standard	bar	16	16	16	16	16	10	10	10	10	10	6	6	6	6
Flanged ends drilled to BST D/E, ANSI 125/150 or metric or to your requirements * Details on application															



Controlling Fugitive Emissions

Warren-Morrison is a conscientious and proactive company, alert to the ever-growing concerns surrounding the importance of preserving our environment. We understand the effects, implications and the overall benefits of helping to prevent fugitive emissions, especially within the petrochemical industry.

Knowing this, Warren-Morrison have responded by developing the most practical means of media containment within the valve assembly. We have achieved this by sufficiently and effectively sealing our spindle necks, position indicators in both the diaphragm valve and also the pinch valve body joint.

Further peace of mind has been introduced as an optional extra. Warren-Morrison is able to provide a "valve fail indication device" (VFID). This device offers visual indication to the user that the serviceable diaphragm or sleeve has failed within the valve, thus prompting responsive remedial action to be taken. This simple but effective device combined with sealed valve technology can be provided at the time of ordering.

The importance of controlling potentially hazardous media types is paramount; we know containment is essential and so is "post failure control". Post failure control is a means of dispelling the media in a safe and controlled fashion. In the unlikely event the diaphragm or sleeve should rupture prematurely, the media will begin to infiltrate the bonnet or body enclosure. The media requires to be safely drained from the valve. On the diaphragm valve and pinch valve, the VFID can be easily removed and the media drained safely and effectively minimizing the risk of exposure to humans and of course the environment.

The VFID is constructed from mild steel that is zinc coated. The working pressure is 16 bar with a work temperature up to 180 C.

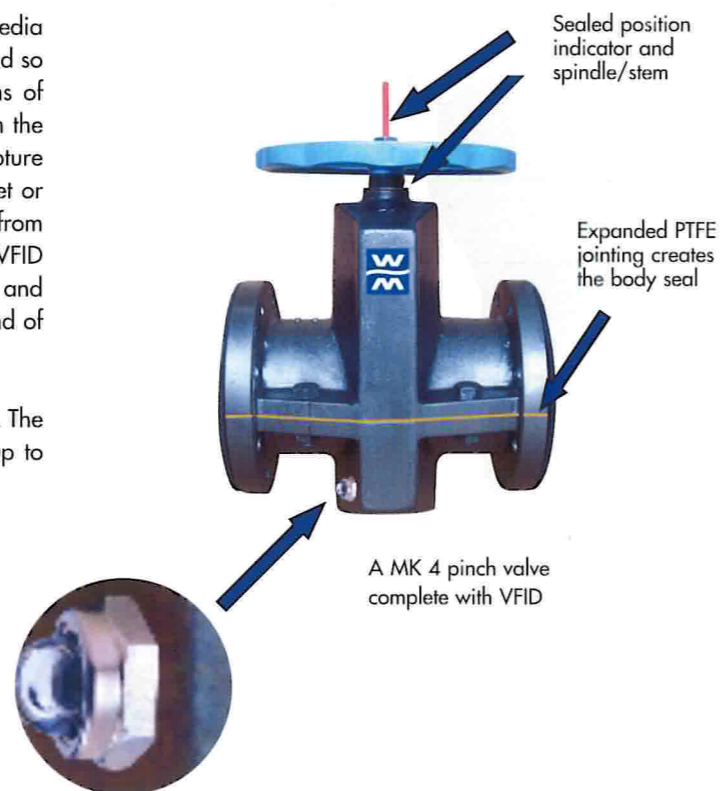
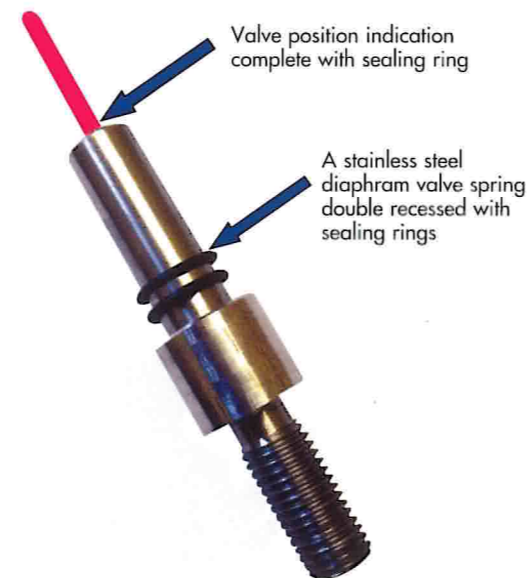

Colour Codes

Diaphragm Materials

Elastomer	Colour Code	Colour Dot	Application	Temperature range
Natural Rubber	Blue	●	General Purpose abrasive elastomer also suitable for sea water application.	-60 to +75 deg C
Butyl	Red	●	Strong Acids & Alkali bases, durable.	-20 to +130 deg C
Neoprene	Yellow	●	General Purpose with better oil & acid resistance than Natural Rubber.	-40 to +95 deg C
Nitrile	White	○	Mineral & Vegetable Oils, Hydrocarbon solvents.	-20 to +100 deg C
Hydrogenated nitrate	White/Blue	○●	Strong aggressive chemicals. Abrasive resistance.	-20 to +180 deg C
Natural Gum Rubber	Light green	●	Soft general abrasion resistant rubber, good compression set, environmentally desirable.	-60 to +75 deg C
HSN Gum	Pink	●	High abrasion - cut / tear resistant rubber.	-50 to +75 deg C
EPDM	Red/white	●○	Food quality, WRC approved for potable water. Can handle short bursts of low pressure steam sterilization.	-50 to +130 deg C
Hypalon® (acid)	Orange	●	Severe service Acids & Alkalis at elevated temperatures.	-25 to +130 deg C
Hypalon® (fire)	Orange/Green	●●	Reinforced with Kevlar, good flame retardancy.	-25 to +130 deg C
PSN	Self coloured brilliant yellow	●	Exceptional abrasion resistance to aggressive slurries, mild chemical use.	-25 to +100 deg C
Viton	Green	●	Outstanding resistance to oils, fuels, lubricants, many aliphatic and aromatic hydrocarbons and most mineral acids.	-20 to +205 deg C
ViTile	Green/White	●○	Similar to Viton, with good adhesion characteristics, very durable.	-20 to +205 deg C
PTFE	Self coloured white	○	Highest chemical resistance at elevated temperatures.	-200to +250 deg C

Hypalon® is a DuPont patent

Pinch Valve Sleeve Materials

Elastomer	Colour Code	Colour Dot	Application	Temperature range
Natural Rubber	Blue	●	General purpose.	-60 to +75 deg C
Butyl	Red	●	Acids & Alkalis.	-20 to +130 deg C
Neoprene	Yellow	●	General Purpose with better oil & acid resistance than Natural Rubber.	-40 to +95 deg C
EPDM	Red/White	●○	Food quality, WRC approved for potable water, short burst of low pressure steam sterilisation.	-50 to +130 deg C
Nitrile	White	○	Mineral & Vegetable Oils, Hydrocarbon solvents.	-20 to +100 deg C
Hydrogenated nitrate	White/Blue	○●	Strong aggressive chemicals. Abrasive resistance.	-20 to +180 deg C
Hypalon® (acid)	Orange	●	Severe service Acids & Alkalis.	-25 to +130 deg C
PSN	Self coloured brilliant yellow	●	Exceptional abrasion resistance and mild chemical use.	-25 to +100 deg C
ViTile	Green/White	●○	Similar to Viton, with good adhesion characteristics, very durable.	-20 to +205 deg C
HSN Gum	Pink	●	High abrasion - cut / tear resistant rubber.	-50 to +75 deg C
Linatex	Self coloured Red	●	Exceptional abrasion resistance.	-30 to +70 deg C

Hypalon® is a DuPont patent



Conversion Tables

Conversions to SI Units

The following conversions have generally been based on BS350. The degree of rounding has been adjusted to an extent considered to be of value to a practical engineer. In the tabulation of conversion factors, the SI unit, or multiple thereof, recommended by the British Valve and Actuators Manufacturers Association for use in the valve industry, is shown in the left hand column.

Length

Table with 5 columns: millimetre (mm), metre (m), inch (in), foot (ft), yard (yd). Rows include 1000, 304.8, 814.4, etc.

Volume

Table with 6 columns: cubic metre (m³), cubic centimetre (cm³), litre (l), cubic inch (in³), cubic foot (ft³), UK gallon, US gallon. Rows include 0.000 001, 0.001, 0.000 016, etc.

Velocity

Table with 5 columns: metre per second (m/s), foot per second (ft/s), foot per minute (ft/min), kilometre per hour (km/h), mile per hour (mph). Rows include 0.3048, 18.288, 0.2778, etc.

Mass

Table with 5 columns: kilogram (kg), pound (lb), hundredweight (cwt), tonne (t), UK ton, US short ton. Rows include 0.4536, 1000, 1016.05, etc.

Mass Rate of Flow

Table with 5 columns: kilogram per second (kg/s), kilogram per hour (kg/h), pound per hour (lb/h), ton per hour (ton/hr), tonne per day (t/d). Rows include 0.000 278, 0.000 126, 0.282 2, etc.

Volumetric Rate of Flow

Table with 6 columns: litre per second (l/s), litre per minute (l/min), cubic metre per hour (m³/h), cubic foot per hour (ft³/h), cubic foot per minute (ft³/min), UK gallon per minute (UK gal/min), US gallon per minute (US gal/min), US barrel per day (US bbl/d). Rows include 0.0167, 0.2778, 0.0079, etc.

Pressure & Liquid Head

Table with 8 columns: bar, kilogram force per square centimetre (kgf/cm²), pound force per square inch (lbf/in²), foot of water, inch of water, metre of water, centimetre of mercury, inch of mercury, millimetre of mercury. Rows include 0.9807, 0.0689, 0.0703, etc.

1 bar = 10^5 N/m². Often denoted non-technically as psi. At density 1g/cm³. Technical (metric) atmosphere (at). International standard atmosphere. Also known as torr.

Pressure Conversions and Equivalents

Head and pressure equivalents are based on pure air-free water at standard atmosphere of 20°C having a density of 0.99823 g/cm³.

Metres head to feet head, bar and lbf/in²

Table with 4 columns: Head (metres), Head (feet), Pressure (bar), Pressure (lbf/in²). Rows include 0.10, 0.20, 0.30, etc.

Feet head to metres head, bar and lbf/in²

Table with 4 columns: Head (feet), Head (metres), Pressure (bar), Pressure (lbf/in²). Rows include 1, 2, 3, etc.

Bar to lbf/in², metres head and feet head

Table with 4 columns: Pressure (bar), Pressure (lbf/in²), Head (metres), Head (feet). Rows include 0.01, 0.02, 0.03, etc.

Pressure Drop and Flow Characteristics of General Purpose Valves

When a valve is inserted into a pipeline, pressure drop, additional to that already present due to pipe friction, is caused by the inevitable changes in shape and direction of flow, eddy currents and obstructions in the seating vicinity and end fittings. The general formula given in this section constitute a guide in establishing the value of this pressure drop for a given size and type of valve, alternatively they establish size and/or type of valve required for a given acceptable value of pressure drop.

Users are advised, whenever possible, to consult Warren-Morrison. It is important to note that the information given relates to the TURBULENT flow region, i.e. where Reynolds Numbers exceed approximately 2000 and which covers the majority of cases.

However, in the few cases where high viscosities or low flow rates drop the Reynolds Number well below 2000, some correction will be necessary.

Liquid Flow

Equations for pressure drop: ΔP = K Q² / S, Q = Cv √(ΔP / S), Q = Kv √(ΔP / S). Includes definitions for K, Cv, Kv, S, ΔP, Q.

Specific Gravity of Liquids

Table listing specific gravity values for various liquids: Water (1.0), Sea Water (1.025), Kerosene (0.8), Sulphuric Acid 100% (1.83), Hydrochloric Acid 45% (1.48), Sodium Hydroxide 25% (1.27), Carbon Tetrachloride (1.60), Petrol (Gasoline) (0.65-0.80), Benzene (0.88), Turpentine (1.1-1.2).

Product Codes

Product code matrix with columns: SPECIALS, END-FLANGE SUITABILITY, BODY TYPE, DIAPHRAGM/SLEEVE, BODY LINING, BODY, SIZE, PRESSURE RATING, VALVE MODEL, ACTUATOR, FLANGE SUITABILITY, SEAT, STEM, BODY, SIZE, PRESSURE RATING, VALVE MODEL. Includes examples for SDV, SFV, GNR, CVD valves.